



# ES5A THRU ES5J

## SURFACE MOUNT SUPER FAST RECTIFIER

Reverse Voltage - 50 to 600 Volts Forward Current - 5.0 Amperes

### DO-214AA/SMB

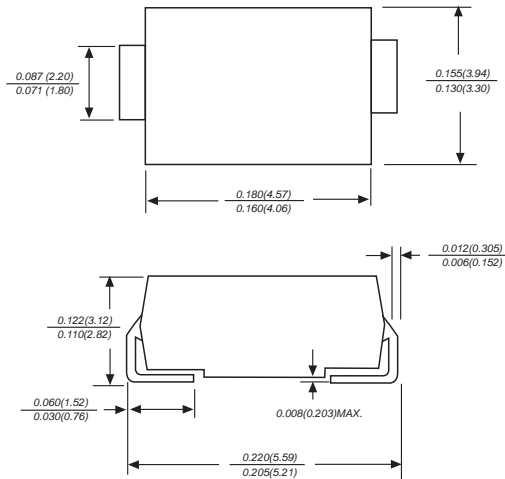

### FEATURES

- ◆ The plastic package carries Underwriters Laboratory Flammability Classification 94V-0
- ◆ For surface mounted applications
- ◆ Low reverse leakage
- ◆ Built-in strain relief, ideal for automated placement
- ◆ High forward surge current capability
- ◆ High temperature soldering guaranteed: 250°C/10 seconds at terminals
- ◆ Glass passivated chip junction

### MECHANICAL DATA

**Case** : JEDEC DO-214AA molded plastic body over passivated chip

**Terminals** : Solder plated, solderable per MIL-STD-750, Method 2026

**Polarity** : Color band denotes cathode end

**Mounting Position** : Any

**Weight** : 0.003 ounce, 0.093 grams

### MAXIMUM RATINGS AND ELECTRICAL CHARACTERISTICS

Ratings at 25°C ambient temperature unless otherwise specified.

Single phase half-wave 60Hz, resistive or inductive load, for capacitive load current derate by 20%.

YXW Catalog Number	SYMBOLS	ES5A	ES5B	ES5C	ES5D	ES5E	ES5G	ES5J	UNITS	
Maximum repetitive peak reverse voltage	$V_{RRM}$	50	100	150	200	300	400	600	VOLTS	
Maximum RMS voltage	$V_{RMS}$	35	70	105	140	210	280	420	VOLTS	
Maximum DC blocking voltage	$V_{DC}$	50	100	150	200	300	400	600	VOLTS	
Maximum average forward rectified current at $T_L=75^\circ\text{C}$	$I_{(AV)}$	5.0							Amps	
Peak forward surge current 8.3ms single half sine-wave superimposed on rated load (JEDEC Method)	$I_{FSM}$	150				135			Amps	
Maximum instantaneous forward voltage at 5.0A	$V_F$	1.0			1.25		1.7		Volts	
Maximum DC reverse current $T_A=25^\circ\text{C}$ at rated DC blocking voltage $T_A=100^\circ\text{C}$	$I_R$	10.0				100.0				$\mu\text{A}$
Maximum reverse recovery time (NOTE 1)	$t_{rr}$	35				ns				
Typical junction capacitance (NOTE 2)	$C_J$	95.0				pF				
Typical thermal resistance (NOTE 3)	$R_{\theta JA}$	45.0				$^\circ\text{C/W}$				
Operating junction and storage temperature range	$T_J, T_{STG}$	-50 to +150				$^\circ\text{C}$				

**Note:** 1. Reverse recovery condition  $I_F=0.5\text{A}, I_R=1.0\text{A}, I_{rr}=0.25\text{A}$

2. Measured at 1MHz and applied reverse voltage of 4.0V D.C.

3. P.C.B. mounted with 0.2x0.2" (5.0x5.0mm) copper pad areas

# RATINGS AND CHARACTERISTIC CURVES ES5A THRU ES5J

**Fig.1 Reverse Recovery Time Characteristic And Test Circuit Diagram**

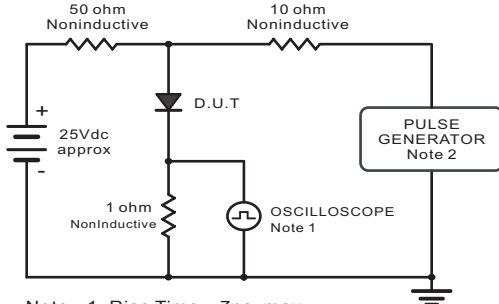

Note: 1. Rise Time = 7ns, max.  
Input Impedance = 1megohm, 22pF.  
2. Rise Time = 10ns, max.  
Source Impedance = 50 ohms.

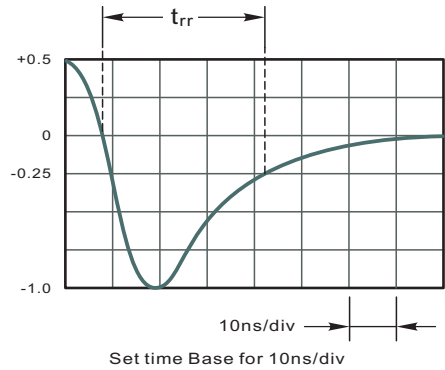

**Fig.2 Maximum Average Forward Current Rating**

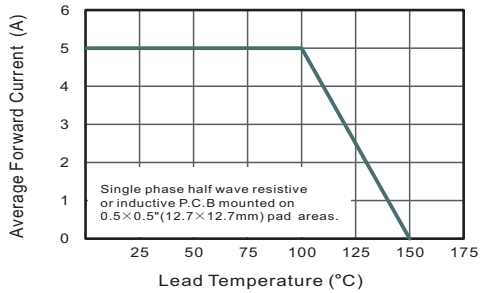

**Fig.3 Typical Reverse Characteristics**

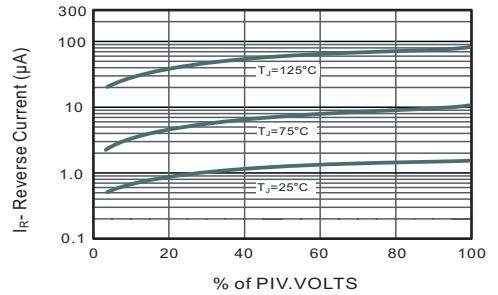

**Fig.4 Typical Forward Characteristics**

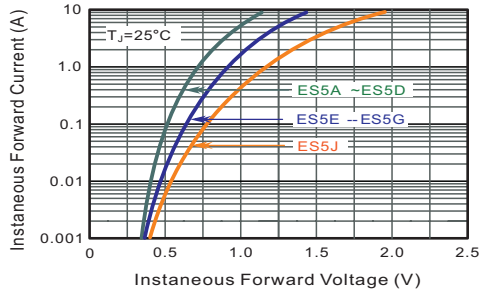

**Fig.5 Typical Junction Capacitance**

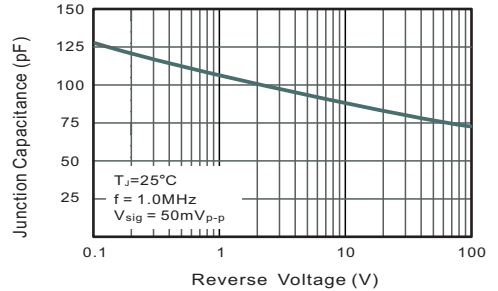

**Fig.6 Maximum Non-Repetitive Peak Forward Surge Current**

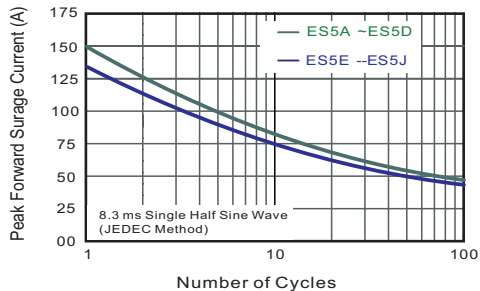

The cruve graph is for reference only, can't be the basis for judgment(曲线图仅供参考!)