

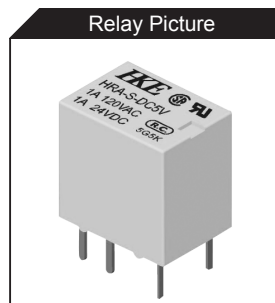

Features	
▪	Microminiature relay
	Dimensions: 10.2×7.4×10.0 (mm)
▪	Light weight
▪	Contact: 1 Form C (SPDT)
Safety Approval	
NO.1063017	US NO.E164730

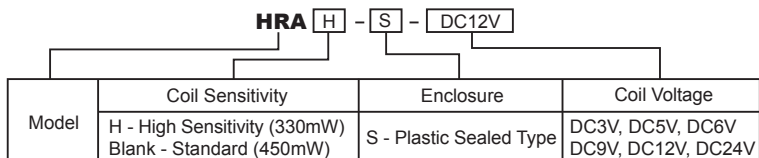

ORDERING INFORMATION



Remarks: 1. Available in 1 Form C only
2. HRAH-S-DC24V: Coil Power 380mW

SPECIFICATION

CONTACT DATA

Contact Form	1 Form C	
Contact Material	AuAg overlay	
Contact Rating	1A 120VAC/24VDC	
Contact Resistance	Max. 50mΩ (6VDC 0.1A)	
Load	Max. Switching Voltage	120VAC/30VDC
	Max. Switching Current	2A
	Max. Switching Power	120VA, 30W
	Min. Switching Load	5VDC, 10mA
Life	Electrical	100,000 operations
	Mechanical	10,000,000 operations

COIL DATA

Nominal Coil Power	330mW, 450mW
--------------------	--------------

GENERAL DATA

Insulation Resistance	Min. 100MΩ 500VDC	
Dielectric Strength	Between open contacts	500VAC, 1min
	Between coil and contacts	500VAC, 1min
Operate Time	Max. 6ms	
Release Time	Max. 4ms	
Operating Temperature	-25°C to +70°C	
Humidity	35~95%RH, +40°C	
Shock Resistance	Endurance	1,000m/s ²
	Misoperation	100m/s ²
Vibration Resistance	Endurance	10~55Hz, 1.5mm double amplitude
	Misoperation	10~55Hz, 1.5mm double amplitude
Weight	Approximately 1.7g	

Note: Data shown are of initial value

SAFETY APPROVAL

File Number	Contact Form	Power Consumption	Coil Voltage	Contact Rating	Remarks
UL E164730	C	0.45W/0.33W	3-24VDC	1A 120VAC/24VDC	Ambient Temperature: 40°C
CSA 1063017(LR 106040)	C	0.45W/0.33W	3-24VDC	1A 120VAC/24VDC	Ambient Temperature: normal

Specifications subject to change without notice

COIL DATA

Ambient Temperature: 23°C

Model	Nominal Voltage VDC	Coil Resistance Ω +/-10%	Operate Voltage \leq VDC	Release Voltage \geq VDC	Coil Power mW
HRA-S-DC3V	3	20	2.1	0.3	450
HRA-S-DC5V	5	55	3.5	0.5	
HRA-S-DC6V	6	80	4.2	0.6	
HRA-S-DC9V	9	180	6.3	0.9	
HRA-S-DC12V	12	320	8.4	1.2	
HRA-S-DC24V	24	1280	16.8	2.4	
HRAH-S-DC3V	3	28	2.1	0.3	330
HRAH-S-DC5V	5	75	3.5	0.5	
HRAH-S-DC6V	6	110	4.2	0.6	
HRAH-S-DC9V	9	245	6.3	0.9	
HRAH-S-DC12V	12	440	8.4	1.2	
HRAH-S-DC24V	24	1515	16.8	2.4	380

OUTLINE, WIRING DIAGRAM, MOUNTING HOLE LAYOUT (UNIT: mm)

Outline

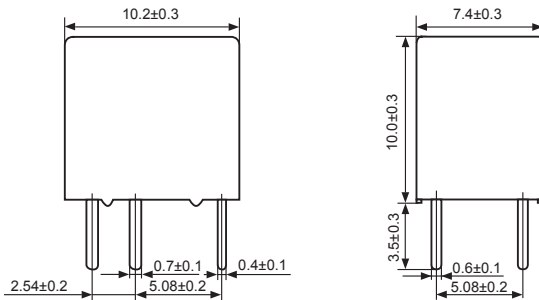

Mounting Hole Layout (Bottom View)

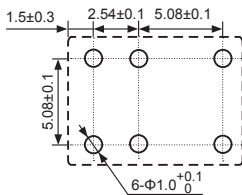

Wiring Diagram (Bottom View)

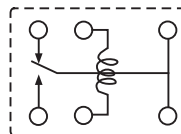

REFERENCE DATA

Time Curve

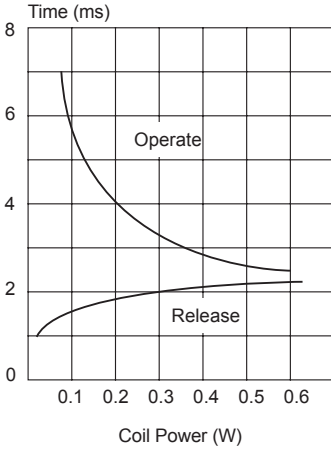

Coil Temperature Rise

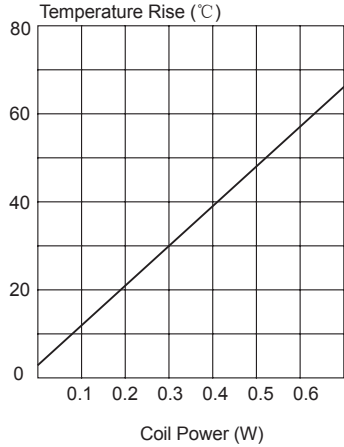

Life Curve

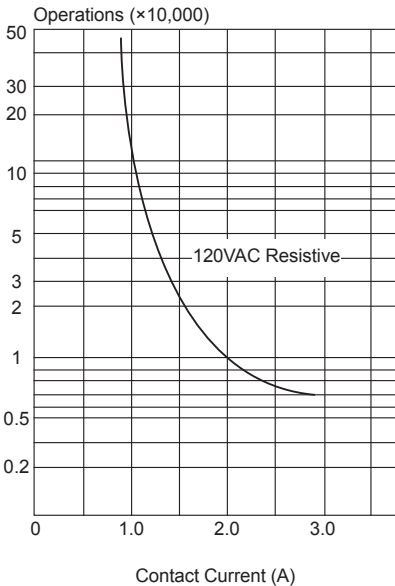

Maximum Switching Power

